

Viraj Daisy Mini Direct Direct Recessed

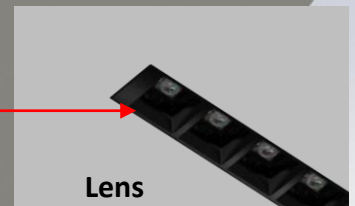

Model no : DL-TVD-MINIDRL-25

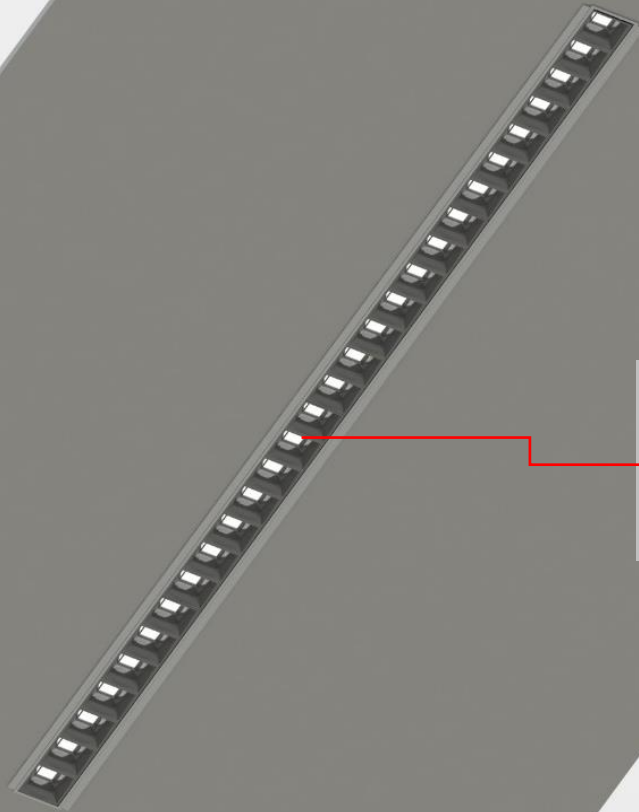

Low-power LEDs



4000K

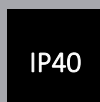

IP40



Excellent thermal management

MACADAM 3



Direct

Structure and Characteristics

The features described here are typical of products in this range. Special versions may offer additional or varying features

1 - Optics

Lens

2 - LED Module

25W

3 - Luminaire head and housing

Aluminium extrusion

4 - Control Gear

NON-Dimmable/Dali-Dimmable

5 - Protection Mode

IP40

6 - CCT

4000K

Dimensions

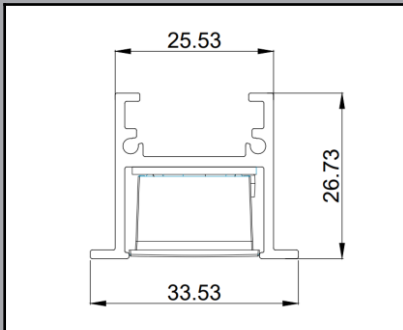

Dimensions

L=1200mm
With Trim W=33.53mm
Cutout W=25.53mm
H=26.73mm

Efficacy

114 lm/W

CRI

≥80

Mounting

Recessed

Life Span

L70 (60,000H)

Beam angle

60°

Dimming

NON-Dimmable/
Dali-Dimmable

Housing Finish

Powder coated

Led Module

25W

CCT

4000K

Input Voltage

220-240 Vac

Power Factor (PF)

0.95

McAdam

3rd

THD

<10%

UGR

<19

